

Feather™

Feather Carbon Fiber 29X Power Wheelchair Owners Manual



Product: Feather Carbon Fiber 29X Power Wheelchair

Sku: F-CF-29XC Brand: Feather

Congratulations on buying the World's Lightest Power Wheelchair!!

At only 29Lbs, the Feather Carbon Fiber 29X Power Wheelchair is one of the lightest wheelchairs in the world. Transporting individuals has never been easier! With brand-new materials, the Feather Wheelchair sets a new standard for lightweight wheelchairs. Anyone can lift this wheelchair into a car, truck, or SUV. The chair also folds down into a compact package. The Feather Power chair is available in an array of color choices and upgrade features.



Feather™

Table of Contents

Introduction.....	2
Precautions For Safe Use.....	3
Performance And Structure.....	13
Technical Features.....	15
Assembling, Folding, And Adjusting.....	16
Use And Operation.....	20
Fault Analysis And Troubleshooting.....	24
Safety Protection Device And Accident Handling.....	24
Maintenance And Repair.....	24
Transportation And Storage.....	27
General Guidance.....	27



Feather™

Introduction

Congratulations on your purchase of the **Feather Carbon Fiber 29X Power Wheelchair!**

It is important that you read through this manual entirely before operating your chair. You will find instructions and recommendations for easy operation of the Feather Power wheelchair.

Read and follow all instructions, warnings, and notes in this manual before attempting to operate your electric wheelchair for the first time. If there is any information in this manual which you do not understand, or if you require additional assistance for assembly or operation, please contact your authorized local dealer. To use your product safely depends on whether you strictly follow the warnings, attentions, and operating instructions in this manual. The company shall not be responsible for any injury or damage caused by non-compliance with the warnings, attentions, and operating instructions.

These symbols below in this manual are used to identify warnings and important information. All of them are very important to your safety. It is strongly recommended that you should read and understand them completely.

Warning! Failure to heed the warnings in the manual may result in personal injury.

Attention! Failure to heed the attentions in the manual may result in damage to the wheelchair.

This product manual is applicable to the Feather Carbon Fiber 29X Power Wheelchair.

- 1) This product integrates advanced technology and modern style. In particular, its quick disassembly and assembly structure is very convenient for you to store or place in the trunk of your car when you travel. We are sure that the design features, excellent performance and trouble free operation of this product will ensure your daily life is more convenient.
- 2) This power wheelchair is applicable for the disabled.
- 3) The maximum weight capacity is 265 lbs.
- 4) This product is an indoor electric wheelchair.
- 5) This electric wheelchair is also suitable for outdoor use, but is limited to flat road sections and cannot be driven on rough surfaces such as steep slopes and gravel roads.

We reserve the right to change and update this manual without notice. The power wheelchair conforms to ISO7176 standard.



Feather™

This manual will help you understand the functions of the wheelchair. In addition, operation, maintenance, and repair are described. If you have any other questions, please contact your dealer or retailer.

【Intended Use】The Electric Wheelchair is a chair equipped with wheels, it is a means for transportation for the disabled, the sick, and the infirm.

【Indications】To be used for the disabled, the sick and the old and infirm who have difficulty in moving.

【Contraindications】This product should not be used for those with slow reaction of the upper limbs, senile dementia, psychopath, physiology, or unable to care for oneself.

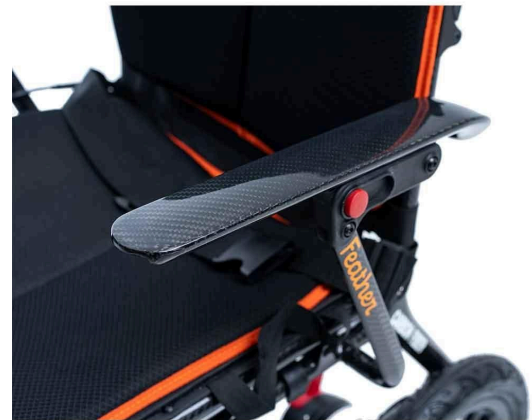

Disclaimer

JYD Imports, HOVER, 1800 Wheelchair, or Feather Mobility, its affiliates, and partners, cannot be held responsible for personal injury or property damage that results from the unsafe or improper operation or maintenance of the Feather wheelchair and/or other JYD Imports, HOVER, or 1800 Wheelchair products purchased.

From time to time, our product development and engineering team will make design updates for this product. We reserve the right to make such changes when deemed necessary to improve on the design or to add value. As a result, there could be minor differences between the product that you have purchased and the photos, illustrations and instructions in this manual.



Feather™

Precautions For Safe Use

Instructions before use.

- 1) Don't operate the motorized wheelchair until you have read the instructions.
- 2) The total weight of people and things shall not exceed the maximum allowable load.
- 3) Don't exceed the maximum allowable gradient.
- 4) Don't go uphill or downhill at maximum speed, otherwise there is danger of rolling over.
- 5) Don't drive on very smooth or soft surfaces, such as smooth tiles, mud, sand, grass.
- 6) Don't drive on slopes without guardrails.
- 7) Don't drive on the motorway.
- 8) Don't turn or drive sideways on ramps, otherwise there is danger of overturning.
- 9) Don't turn or drive laterally on the ramp, or you may roll over. Do not reverse on the ramp, or you may roll over.
- 10) Don't climb above the maximum permissible barrier height.
- 11) Please fasten your seat belt when using the power wheelchair.
- 12) Keep your feet and hands on the pedals and armrests at all times.
- 13) When operating the wheelchair for the first time, please practice using a wheelchair outdoors before you can go on the road.
- 14) Please pay attention and don't be distracted when the wheelchair is driving.
- 15) Please take the pedestrian crossing when crossing the road.
- 16) Please pay attention to the power display during wheelchair driving.
- 17) Don't cross the road when the power is low, so as not to run out of power halfway.
- 18) If the wheelchair is not used for a long time, it should be folded and stored in a dry and ventilated place.
- 19) The wheelchairs should not be stored in high temperatures and humidity.
- 20) Pay attention when in use.
- 21) This power wheelchair can drive on good flat surfaces; do not drive on muddy, rugged, soft, narrow, icy roads, or bad roads such as dangerous roads without guardrails or waterways.
- 22) This power wheelchair has the certain ability of groove obstacle, at this time you should reduce the speed and travel slowly.
- 23) This power wheelchair has a certain climbing ability, the climbing angle is $\geq 3^\circ$, but no more than 10° .
- 24) Please avoid driving in crowded and heavily trafficked areas.
- 25) Please ensure that the control system is firmly installed, the joystick is vertical, and correctly positioned. Please sit up well and buckle the seat belt, keep your head as far back as possible, and lean against the backrest in case of an out of control movement.



Feather™

- 26) Before pressing the on/off button, always check if the current fastest speed setting is appropriate for yourself operating proficiency, or it should be adjusted for safety. We recommend driving slowly at the beginning for each use and gradually accelerate.
- 27) Indications for use: The Feather power electric wheelchair is a motor driven, indoor and outdoor transportation vehicle with the intended use to provide convenience for disabled and elderly individuals with limited mobility. This product is suitable for disabled people and elderly people with limited mobility.

Electromagnetic interference (EMI)

Electromagnetic interference is from external electromagnetic wave energy (like radios, TV transmission stations, CB radio waves, and garage door starters, radio phones, and more) Electromagnetic interference may affect the control system of the power wheelchair. Some interference may lead to the brake failure, powering on automatically, or steering failure. It may also lead to the permanent damage of the control systems. Below cable information is provided for EMC reference.

Cable	Max Cable Length, Shielded/Unshielded		Number	Cable Classification
AC Power Line	6 feet	Shielded	1Set	AC Power
DC Power Line	4 feet	Shielded	1Set	DC Power

Important information regarding Electromagnetic Compatibility (EMC)

This electrical medical equipment needs special precautions regarding EMC and put into service according to the EMC information provided in the user manual; The equipment conforms to this IEC 60601- 1-2:2014 standard for both immunity and emissions. Nevertheless, special precautions need to be observed: The equipment with ESSENTIAL PERFORMANCE/Following ESSENTIAL PERFORMANCE is intended to be used in a Home healthcare environment.

Feather™

ESSENTIAL PERFORMANCE

The electric wheelchair can work normally without moving out of control, and the speed change is not more than $\pm 20\%$.

WARNING: Use of this equipment adjacent to or stacked with other equipment should be avoided because it could result in improper operation. If such use is Necessary, this equipment and the other equipment should be observed to verify that they are operating normally. The use of accessories, transducers, and cables other than those specified or provided by the manufacturer of this equipment could result in increased electromagnetic emissions or decreased electromagnetic immunity of this equipment and result in improper operation.

WARNING: Portable RF communications equipment (including peripherals such as antenna cables and external antennas) should be used no closer than 30 cm (12 inches) to any part of the Feather power chair, including cables specified by the manufacturer. Otherwise, degradation of the performance of this equipment could result.

WARNING: If the use location is near (e.g. less than 1 mile from) AM, FM, or TV broadcast antennas, before using this equipment, it should be observed to verify that it is operating normally to assure that the equipment remains safe with regard to electromagnetic disturbances throughout the expected service life. When the AC input voltage is interrupted, the equipment will stop battery charging and if the power supply restored, it could be recovered automatically, this degradation could be accepted because it will not lead to unacceptable risks and it will not result in the loss of basic safety or essential performance.

Feather™

EMI Compliance Table (Table 1)

Table 1 - Emission

Phenomenon	Compliance	Electromagnetic environment
RF emissions	CISPR 11 Group 1, Class B	Home healthcare environment
Harmonic distortion	IEC 61000-3-2 Class A	Home healthcare environment
Voltage fluctuations and flickering	IEC 61000-3-3 Compliance	Home healthcare environment

EMS Compliance Table (Table 2-5)

Table 2 - Enclosure Port

Phenomenon	Basic EMC standard	Immunity test levels
		Home healthcare environment
Electrostatic Discharge	IEC 61000-4-2	±8kV contact ±2kV, ±4kV, ±8kV, ±15kV air
Radiated RF EM field	IEC 61000-4-3	20V/m 26MHz-2.5GHz 80% AM at 1kHz 10V/m 80MHz-2.7GHz 80% AM at 1kHz
Proximity fields from RF wireless communications equipment	IEC 61000-4-3	Refer to table 3
Rated power frequency magnetic fields	IEC 61000-4-8	30A/m 50Hz or 60Hz

Table 3 – Proximity field from RF wireless communications equipment

Test frequency (MHz)	Band (MHz)	Immunity test levels
		Home healthcare environment
385	380-390	Pulse modulation 18Hz , 27V/m
450	430-470	FM , ±5kHz deviation , 1kHz sine , 28V/m
710	704-787	Pulse modulation 217Hz , 9V/m
745		
780		

Feather™

810	800-960	Pulse modulation 18Hz , 28V/m
870		
930		
1720	1700- 1990	Pulse modulation 217Hz , 28V/m
1845		
1970		
2450	2400-2570	Pulse modulation 217Hz , 28V/m
5240	5100-5800	Pulse modulation 217Hz , 9V/m
5500		
5785		

Table 4 – Input a .c . power Port

Phenomenon	Basic EMC standard	Immunity test levels
		Home healthcare environment
Electrical fast transients/burst	IEC 61000-4-4	±2kV 100kHz repetition frequency
Surges Line-to- line	IEC 61000-4-5	±0.5kV, ±1kV
Conducted disturbances induced by RF fields	IEC 61000-4-6	3V, 0.15MHz-80MHz 6V in ISM bands and amateur radio bands between 0.15MHz and 80MHz 80%AM at 1kHz
Voltage dips	IEC 61000-4- 11	0% UT; 0.5cycle At 0°, 45°, 90°, 135°, 180°, 225°, 270° and 315°
		0%UT; 1 cycle and 70% UT; 25/30 cycles Single phase: at 0°
Voltage interruptions	IEC 61000-4- 11	0% UT; 250/300 cycles UT=rated input voltage

Table 5 – Signal input/output parts Port

Phenomenon	Basic EMC standard	Immunity test levels
		Home healthcare environment
Electrostatic Discharge	IEC 61000-4-2	±8kV contact ±2kV, ±4kV, ±8kV, ±15kV air

Feather™

WARNING! Please observe the WARNINGS below to avoid any damage or injury resulting from improper use of your wheelchair. The wheelchair user is responsible for taking proper safety measures. We will not be liable for personal injury and/or product damage resulting from improper use of the wheelchair. Obey all local pedestrian traffic rules. It may be difficult for others to see you when you are seated in your wheelchair. Wait until your path is clear of traffic, and then proceed with extreme caution.

ATTENTION: Use of safety devices such as reflectors, reflective clothing, lights, and safety symbols is very important for your safety while driving.

WARNING! NEVER try a new maneuver on your own, out of the manual stated.

WARNING! Do not use the wheelchair other than for its original purpose. Avoid any use, such as weight training, sports and athletics, hauling, moving, or towing anything, that may lead to safety hazards and undue stress on the wheelchair.

WARNING! We strongly recommend that you do not smoke cigarettes while seated on your wheelchair. You must adhere to the following safety guidelines if you decide to do so: Keep ashtrays a safe distance from the seat cushions. Always make sure cigarettes are completely extinguished before disposal.

WARNING! Before getting on/off the wheelchair, you should sit behind as far as possible to avoid injury caused by overturning.

WARNING! Avoid holding on the armrest, which will cause rollovers and injuries.

WARNING! Avoid concentrating your weight on the footrest. Otherwise, it will cause overturning and personal injury.

WARNING! Do not use the wheelchair in manual mode without accompanying the person, which may cause personal injury.

WARNING! When sitting in the wheelchair, please do not move by yourself, which may cause personal injury. Ask your accompanying person for help if necessary.





Feather™

 **WARNING!** Do not make any alterations to the wheelchair without permission . Adding accessories may change some of the wheelchair specifications such as total weight , size , or center of gravity. Please note that some changes may damage things around you.

 **WARNING!** Please do not change your seat specifications Do not place any cushions or pillows on the seat , which will result in the user falling out from the wheelchair caused by instability of seat.

 **WARNING!** Be extremely careful when using oxygen near electrical circuits or combustible materials. Please contact your oxygen supplier for information on the safe use of oxygen.

 **Attention!** Do not change the controller Settings. Please ask your service provider to check it if you notice any changes in your ability to control the wheelchair.

 **WARNING!** During the operation , the wheelchair may suddenly stop at any time Do not operate wheelchair if it is abnormal or irregular.

 **WARNING!** To prevent the wheelchair from losing control and moving on its own , do not place the wheelchair in manual mode on any inclined plane.

 **WARNING!** If you expect to sit in a fixed position for a long time , turn off the power to prevent movement of the wheelchair.

 **WARNING!** Avoid any accessories that may interfere with the operation of the joystick . Otherwise , it will cause the wheelchair to move unexpectedly.

 **WARNING!** Keep yourself, clothing and other objects away from the wheel while the wheelchair is moving. Do not drag anything behind the wheelchair while driving.

 **Attention!** Do not connect any other devices to the electronic system or turn on any other devices with the wheelchair battery.

 **Attention!** When disconnecting wiring harness , please hold the terminal in case damage to it . Do not pull the wiring harness directly.

 **WARNING!** Keep all charger connector terminals clean and dry, away from damp sources to prevent damage to electrical system and personal injury.

Feather™

⊗ Attention! The storage temperature of wheelchair is 0°C~50°C . Long term storage in low or high temperature environment will damage its function.

⊗ Attention! Always check electrical components for Corrosion.Check all brakes for looseness,wear or Damage.Check wiring harnesses and terminal posts for breakage.If necessary, please do the replacement.

⊗ Attention! Please ensure the safety of wheelchairs and batteries during transportation.Never transport wheelchairs or batteries with combustible materials.

⊗ Attention! Do not connect the cable directly to the battery terminal/clip for charging.

⊗ Attention! Do not remove the fuse from the battery harness . If the fuse is damaged , please contact your supplier for replacement.

⚠ WARNING! Do not operate the wheelchair with dead battery. You might get trapped.
WARNING! Please slow down when turning,don't make sharp turns,keep the center of gravity stable when turning.To prevent rollover,do not move the center of gravity in the opposite direction when turning.
⚠ WARNING! Drive straight up the slope when climbing . Both front wheels should land at the same time .To reduce the possibility of overturning,do not make an angle with the slope;do not make the wheel on one side or the side of the wheelchair to go up the slope first. Be particularly careful when climbing any slopes.

⚠ WARNING! Do not drive on potentially dangerous roads or slopes, including but not limited to roads covered with snow, ice , cut grass,or wet leaves .

⚠ WARNING! Please drive down a slope at the minimum speed. If the descent speed is faster than expected, release the joystick lever to stop the wheelchair, and then press the lever lightly to control the descent speed.

⚠ WARNING! Do not place the wheelchair in the front seat of vehicle during transportation .Otherwise,it may move and disturb the driver.

⊗ Attention! Please contact your service provider if any accessories of seat unit become loose; Please replace the worn or damaged parts immediately.

Feather™

 **WARNING!** The recommended maximum climbing angle (see parameter table) was tested in a controlled environment. The climbing ability of your wheelchair is affected by factors such as your weight, the speed of your wheelchair, and the angle at which you approach the slope.

 **WARNING!** Reversing is only possible on flat roads. When reversing, please operate smoothly at low speed. Please stop frequently and check to make sure there are no obstacles on the road. To prevent rollover, do not tilt down or backward along the slope.

 **WARNING!** When sitting in a wheelchair, avoid any position or movement that can change your center of gravity. This may cause the wheelchair to tilt.
WARNING! Do not put all the weight on one side of the wheelchair armrest, such use may cause the wheelchair to tilt.

 **WARNING!** Do not put your hands above the seat or tilt your body. This may damage the backrest and cause you to fall down.

 **WARNING!** Even if your wheelchair can cross high obstacles, we recommend that you do not try to cross the specified height. Such operations may cause the wheelchair to be unstable, even rollover and cause severe personal injury. If you have any concerns about safely crossing obstacles, please ask for help. Please pay attention to your operating skills and personal restrictions. You may need to remove or cover the sills and install ramps at exits and entrances.

 **WARNING!** Do not attempt to climb over obstacles on.
WARNING! Do not rely on a wheel to get over obstacles.

 **WARNING!** Never operate the wheelchair near railroad tracks or crossings.

 **WARNING!** Do not drive the wheelchair along the edge of a stream, lake or sea.
Please do not drive the wheelchair across the water.

 **WARNING!** Do not expose wheelchair to open flames.

Feather™

⊗ **ATTENTION!** Keep your wheelchair in a dry and clean environment. Don't take the wheelchair to shower, bath, pool or sauna. Rain, snow, salt, fog / spray conditions and frozen / smooth surfaces can cause wheelchair screws and some fixtures to rust untimely.

⊗ **ATTENTION!** Avoid prolonged exposure to excessively hot and cold environments; it may damage the cushioned and non-cushioned parts of the wheelchair as well as the battery and battery components.

⊗ **ATTENTION!** Do not drag the wheelchair. Dragging may exceed its own speed threshold, causing damage to key parts of the wheelchair.

⊗ **ATTENTION!** Be extremely careful when moving an idle wheelchair up and down the stairs. The wheelchair must be folded, requiring the participation of physically capable people.

⚠ **WARNING!** Do not cross stairs or escalators with the wheelchair.

⚠ **WARNING!** Do not sit on a wheelchair while it is in any transport vehicles.

⚠ **WARNING!** For safer handling: Always keep the power off before moving. Failure to do so may result in touching the joystick and causing the wheelchair to move unexpectedly. Make sure the brakes are locked so to prevent the wheelchair from moving during handling. This wheelchair could be driven into the elevator, while you must turn off the power and sit firmly to ensure that the wheelchair will not move after entering the elevator.

⚠ **WARNING!** Do not operate your wheelchair while you are under the influence of alcohol, as this can impair your ability to safely operate your wheelchair.
⚠ **WARNING!** Every wheelchair is different. Take the time to learn it before your driving.
⚠ **WARNING!** BE AWARE that becoming a capable and safe wheelchair operator will take time and practice.

Feather™

WARNING! Radio wave sources , such as radio stations , television stations , amateur radio transmissions , two-way radios and mobile phones can affect wheelchair control .

The following **WARNINGS** should reduce the possibility of severe injury due to accidental braking or movement of the power wheelchair:

1. Do not turn on portable personal communication devices , such as citizen band (CB) radios and mobile phones when the power wheelchair is powered on;
2. Pay attention to nearby transmitters , such as radio or television stations , and try to avoid approaching them .
3. In the event of unexpected movement or brake release , the power wheelchair should be turned off as soon as possible under safe conditions;
4. Please note that adding accessories or parts, or modifying power wheelchairs may make it more susceptible to interference from radio wave sources (note: there is no easy way to assess the influences of above modifications on the wheelchair's overall immunity from radio wave sources); and report to the power wheelchair manufacturer of all accidents of unexpected movement or brake release , and pay attention to nearby radio sources and other important information.



Attention! Please return the discarded batteries, controllers , motors ,etc. to the supplier or manufacturer for disposal to avoid environmental pollution.



WARNING! To ensure your safety, please read and understand this manual . You must be on high alertness when driving any wheelchair to ensure safety.



WARNING! Please consult your healthcare professionals routinely to ensure there are no health or physical conditions that may limit or impair your ability to safely operate your wheelchair. Consult your physician if you are taking prescription or over-the-counter medication or if you have any physical limitations. Some medications and physical limitations may impair your ability to safely operate your wheelchair.



Feather™

Performance And Structure

Product Structure

The Power wheelchair is mainly composed of front wheel, drive wheel, frame, controller, motor and drive devices, armrest, push-handle, backrest, seat cushion, footrest, battery box, and charger. The structural diagram is below.

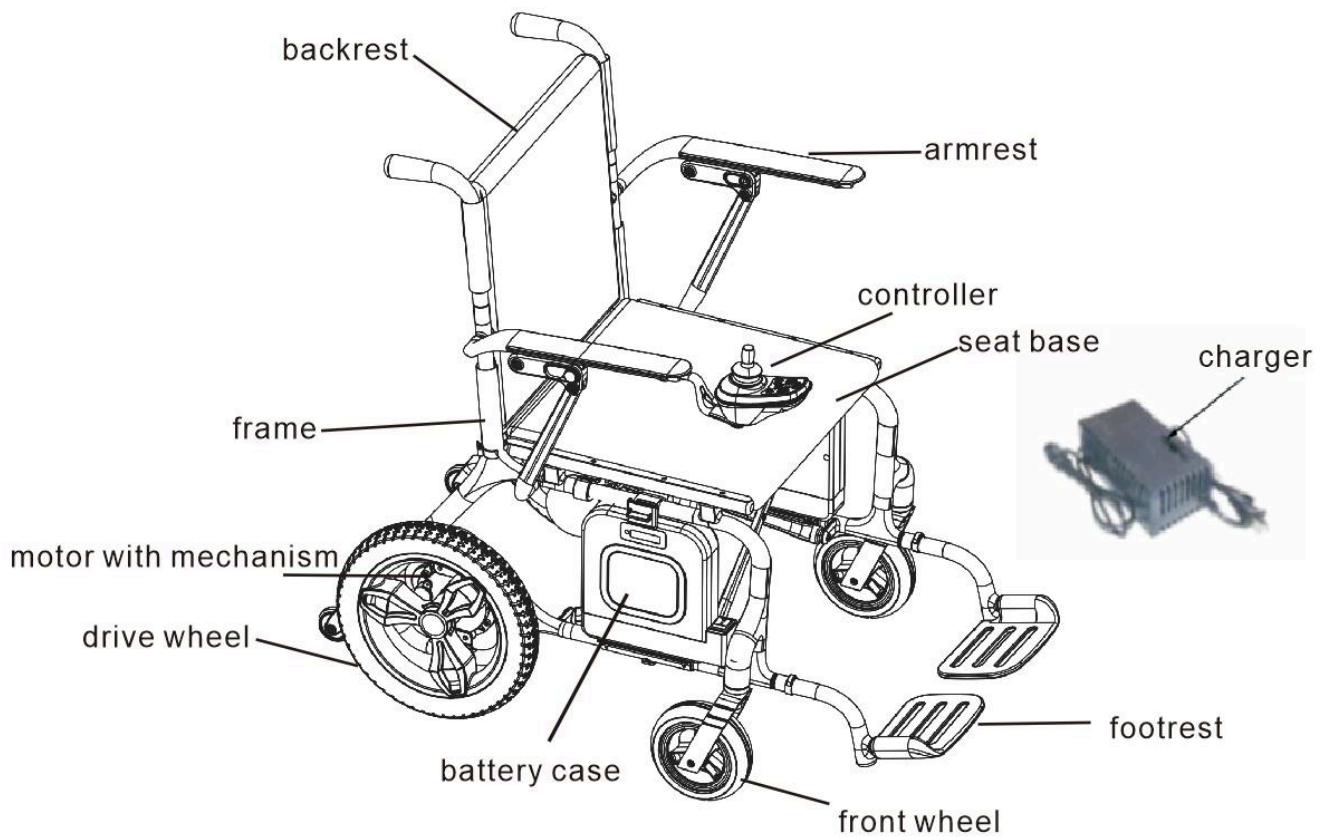

Feather™

Product characteristics of the electric wheelchair.

- Classification by anti-shock type: wheelchair is internal power supply;
- Classification according to the degree of anti-shock: wheelchair belongs to the B-type application part;
- Classification according to the degree of protection of the feed: IPX0;
- Safety degree when used in flammable anesthesia mixed with air or flammable narcotic with oxygen or oxidized nitrogen Category: Non-AP or APG equipment;
- By operating mode: continuous operation;
- Wheelchair rated voltage and frequency: DC 24V;
- Input power of wheelchair: internal power supply equipment; Whether the wheelchair has a protective effect on defibrillation effect: No;
- Whether the wheelchair has a signal output and input part: No;
- Permanent installation of equipment or non-permanent installation of equipment: mobile devices

Electric diagram of power wheelchair

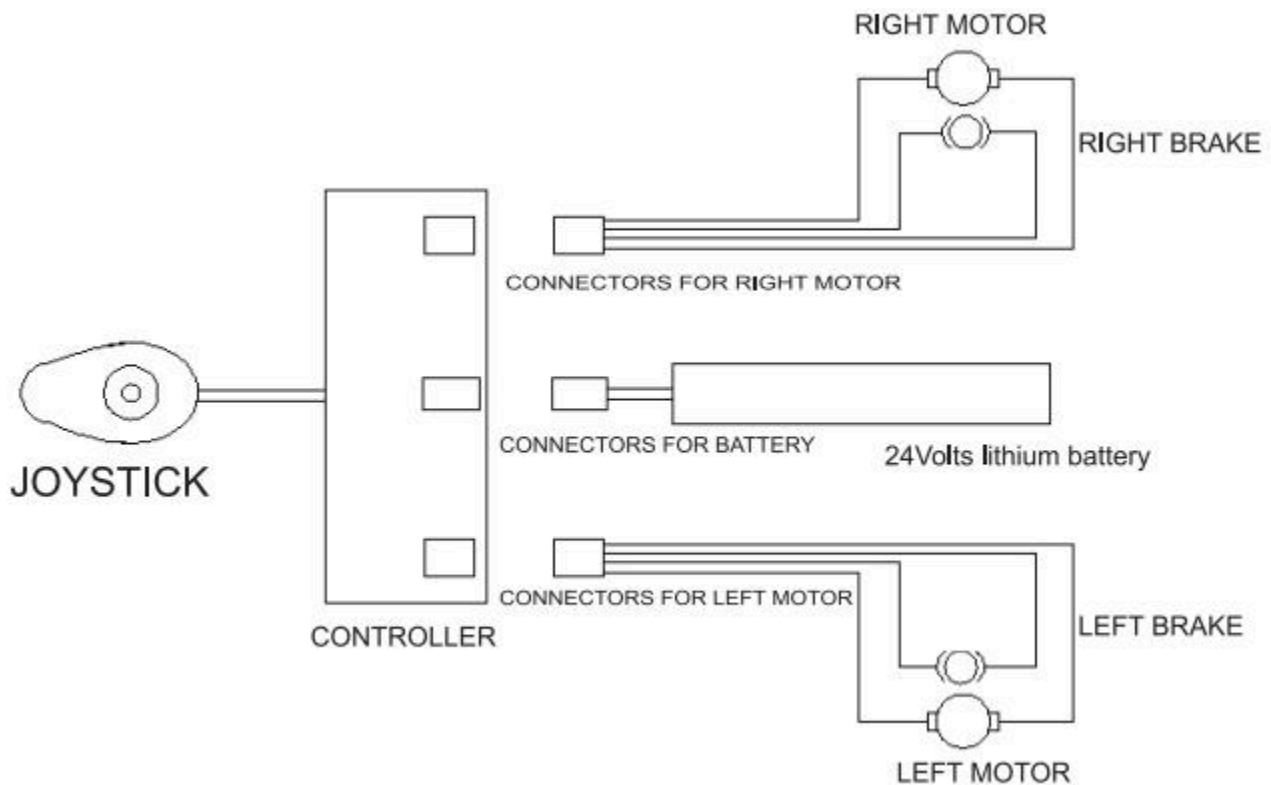

Feather™

Product Specifications

Weight Capacity	265 lbs
Product Weight (without battery)	29 lbs
Seat Width	18"
Seat Depth	16"
Seat-to-Floor Height	19"
Seat Back Height	15"
Overall Width	25"
Overall Depth	38"
Overall Height	34"
Folded Width	14"
Folded Depth	29"
Folded Height	34"
Front Wheel Size	7"
Rear Wheel Size	12"
Armrest Type	Flip Back, Full Length
Armrest Height	9"
Wheel Material	Solid, Polyurethane, No Fill
Brakes	Electromagnetic
Legrest Type	Fixed, Foldable foot plates
Planar Angle	3.5°
Maximum Clearance	1"
Maximum Speed	4mph
Minimum Turning Radius	35"
Backrest Angle	8.5°
Driving Distance	6 miles
Maximum Climbing Degree Angle	3°

Feather™

Motor Model	24V/150W (two)
Lithium Battery Specification	24V, Capability: 6.0 amp hours (144 Wh)
Maximum Output Current of Controller	50A
Maximum Output Current of Charger	2A

**Maximum Potential Range is tested on a flat road with average speed, it will vary due to drive surfaces, operation habits, end user weight load, and more.

Assembling, Folding, And Adjusting

- 1) Place the wheelchair on the ground, pull the left and right frames apart, and push down the seat bottom.



Feather™

- 2) Lift the handles upward on both sides until the spring clasp snaps into the holes.



- 3) Attach the pedal assemblies to the frame, align it with the holes, and snap the latches in.

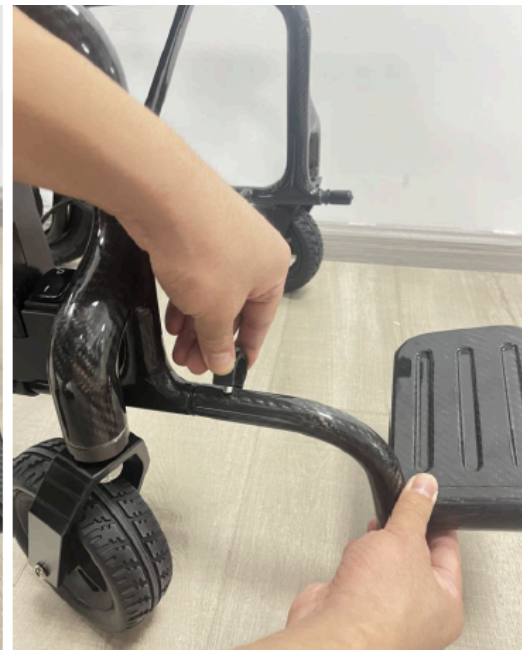

Feather™

- 4) Push up the battery latch switch and then rotate the battery to remove.
 - a) [I} Power on the Right, [II} Power on the Left, [O} No Power Supply connected



- 5) Insert the joystick controller into the armrest tube. Keep the controller horizontal and lock the screw. Connect the joystick controller wires and armrest mounting bracket lock nut.



Feather™

- 6) With one hand press in the armrest button, then flip up the armrest. Complete by pressing down on the armrest to the proper position to the proper height.

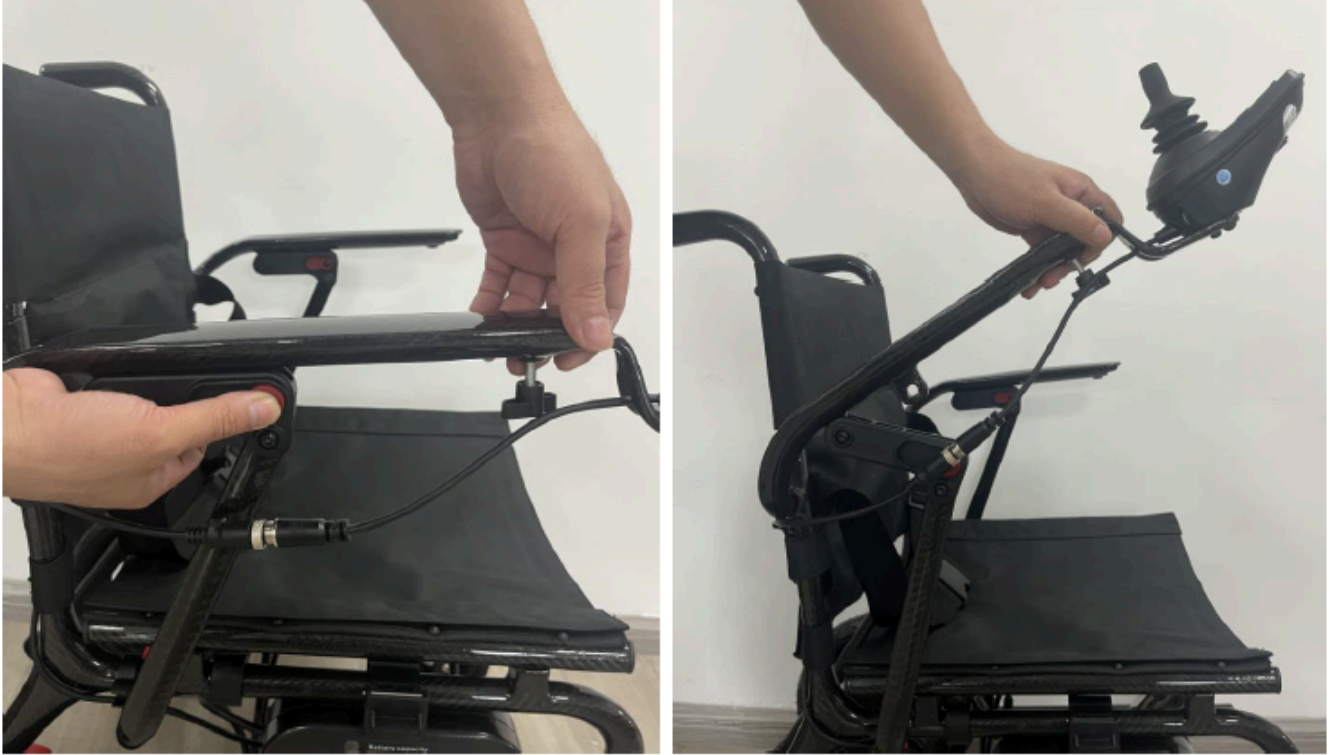

- 7) There are small red levers on the left hand and right hand rear wheel motors. Pull back on the levers to set manual mode (unlocked) and push forward on the levers to engage electric/power/drive mode (lock). For proper operation, both levers must always be in the same position.

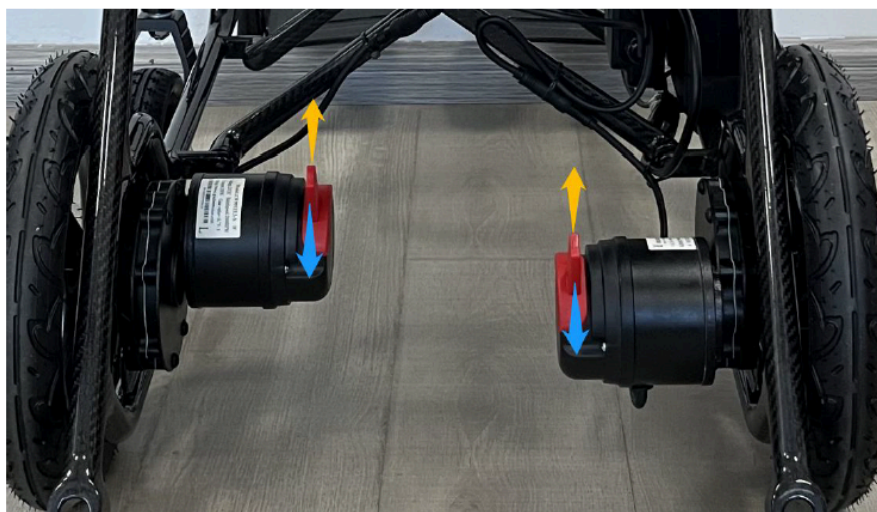

Feather™

If your wheelchair was equipped with rear anti-tippers, you can also install them to the rear frame.

The seat back and overlay pieces are made with a durable synthetic nylon mesh material and are fully machine washable. They must be air dried to avoid over drying in a commercial dryer. Additional seat overlays in multiple color choices are available to purchase online at, <https://feathermobility.com/>

Use And Operation

All the electric components to control the wheelchair are integrated to the main joystick controller, including ON/OFF power button; battery power gauge; speedometer speed light; speed increase button; speed decrease button; horn button; and joystick navigator rod. You can implement all the operations of this wheelchair with the above buttons.



The ON/OFF power button: Is the switch to supply power to the control system. Press the power button to turn the power on. The power indicator speed light and battery gauge will also turn on. Press it again, the power is off, then the speed light and the battery gauge will also turn off.



Feather™

Speed decrease button: After turning on the power, the speed light displays the current maximum driving speed, and will decrease by one bar with each press on it. The number of displayed bars represents the current maximum driving speed. The range can be adjusted by the user.

Speed increase button: After turning on the power, the speed light displays the current minimum driving speed, and will increase by one bar with each press on it. The number of displayed bars represents the current maximum speed. The range can be adjusted by the user.

Battery power gauge: This displays the battery storage. All bars light: power is sufficient; 3-4 bars displayed indicates the power is OK. Lower than 2 bars indicates lack of power and the battery needs to be charged.

Joystick: The joystick is mainly used to control the wheelchair's movement including its speed and direction (forward, backward and left or right) The further you push the joystick from its central position, the faster the wheelchair moves. Whenever you release the joystick, it will automatically go back to the center and the brake will be automatically engaged to stop the wheelchair.

Speedometer speed light: The speed is divided into 5 gears. The speed in the first and lowest gear is 1mph, the fast speed at the highest and fastest gear is 4mph.

Charger Socket: It is only used for this wheelchair. Do not use the socket to supply power to any other electrical equipment. Otherwise, it may damage the wheelchair's control system or its E.M.C performance (Electromagnetic tolerance)

WARNING! Avoid any accessories that may intervene the operation of joystick. Otherwise, the wheelchair may move accidentally.

WARNING! If your wheelchair moves accidentally, please immediately release the joystick and the chair will stop automatically.

CAUTION! If you connect any devices other than the supplied battery charger into the socket, causing damage to the control system, then the warranty is invalid.

WARNING! Do not press the joystick hard by hand when getting on/off the wheelchair to avoid any accident.



Feather™

Charging the Battery

The battery charger is an important part of the wheelchair. The off-board charger attached to this product can charge its batteries quickly and easily to make your wheelchair the best. Do not operate the wheelchair while charging.

Battery and Usage

Fully charge your new battery prior to its initial use. This brings the battery up to about 90% of its peak performance level; Give the battery another full charge of 4-6 hours and operate your wheelchair again, the batteries will now perform at over 90% of their potential. After four or five charging cycles, the batteries will top off at 100% charge and last for an extended period. Please replace a new battery when the battery fails, and the old battery must be returned to the supplier because of environmental pollution.

CAUTION! Do not use your wheelchair when the temperature is less than -25°C or above 50°C.

Battery Removal & Replacement

The battery can be removed from the wheelchair and recharged. If the battery needs to be replaced, release the battery pack buckle underneath the seat, and then take it out.



Feather™

ATTENTION! Please replace the battery with the same type, chemical substances and capacity. Please select the battery type and capacity per specification in the manual. Please use the replacement battery directly provided by the authorized supplier(s) to ensure the performance and function, backward operation, and pay attention to the speed control setting. And the backward speed should be lower than forward speed.

ATTENTION! Please protect the battery from freezing; Please do not charge the frozen battery, otherwise the battery may be damaged.

Operation

- Do not turn on the power switch when sitting on the power wheelchair, and do turn off the power switch when getting off from the wheelchair. Please observe whether the hand brake works or not.
- Please fold the pedal first then hold the armrest to sit on the wheelchair; Do not get off the wheelchair by stepping on the pedal. Otherwise the chair may be turned over, which is dangerous.
- Find a spacious place like a square and have an assistant to help you practice until you have enough confidence to operate it.
- Be certain to shut down the power when you up and down the wheelchair, and set a speed you need through the speed adjustment button.
- We recommend you set the lowest speed until you can operate the electric wheelchair skillfully.
- To Practice the stop operation, forward and backward. Push the handle, the wheelchair moves to anywhere you want.
- Firstly, ensure that it is the lowest speed when practicing forward operation. After Skilled, you can practice "S" shaped turns. After you are familiar with "S" shaped turn, to practice

WARNING! Do not use your wheelchair unless getting help form your assistant when the wheelchair is in manual mode. Otherwise it may result in personal injury. Do not set your wheelchair in manual mode by yourself while you are seated in the wheelchair. Otherwise it may result in personal injury. In this case, please ask your assistant to help you. Do not set your wheelchair in manual mode when it is on an incline. Otherwise, the wheelchair could be out of control to roll down by itself, and result in personal injury.

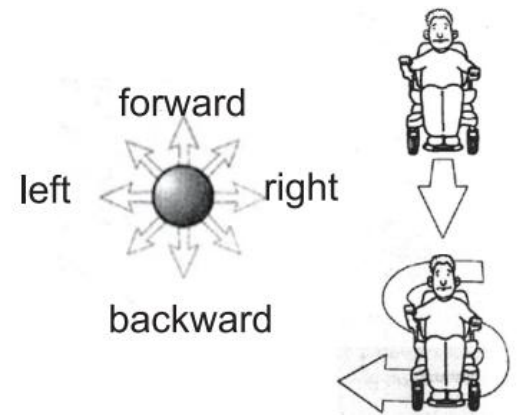

Feather™

Fault Analysis And Troubleshooting

For your convenience, this wheelchair is equipped with an automatic fault warning device. Once it is out of order, the controller panel will display the pattern and the horn will sound. You can find where the fault is according to the table below. If the fault persists after checking, please contact your service agent.

Light Status	Probable Cause	Solutions
First battery indicator light flashes	The battery power is drained and too low for operation	Charge the battery fully before use.
First to fifth battery indicator lights flash	Battery voltage is too high	The charger or lithium battery protection board is abnormal or faulty. Test separately and replace the charger or battery as needed.
First to fifth battery indicator lights flash in increments	The battery is currently charging	Do not use the wheelchair or operate while charging.
First to fifth battery indicator lights flash in increments	The left hand rear wheel motor is malfunctioning	Check the left motor connection cable and wiring. Fully disconnect and reconnect. Swap the plugs for the LH and RH motors. If the first great light flashes, the left hand motor is faulty. If the second great light still flashes after swapping, the controller is faulty.
Second battery indicator light flashes and first gear flashes	Left hand electromagnetic brake failure	Check the left motor connection cable and wiring. Fully disconnect and reconnect. Check if the electromagnetic brake is in electric mode (locked state).
First battery indicator light flashes and first gear flashes	The right hand rear wheel motor is malfunctioning	Check the right motor connection cable and wiring. Fully disconnect and reconnect. Swap the plugs for the LH and RH motors. If the first great light flashes, the right hand motor is faulty. If the second great light still flashes after swapping, the controller is faulty.

Feather™

ATTENTION! In order to ensure the quality of the wheelchair, during the maintenance, if any consumable parts such as battery, wheels, joystick, motor/actuator and charger need to be replaced, please contact this company or dealer, replacing the original parts of the same model and specification.

Maintenance And Repair

Like other motorized vehicles, your power wheelchair also requires routine maintenance. Some checks can be performed by yourself, others you can ask for assistance from your service agent. Preventive maintenance is very important. If you follow the maintenance and checks in this section, your wheelchair will give you years of trouble-free operation. For any questions regarding the maintenance or operation of the wheelchair, please contact your dealer or our after-sales service dept.

In order to ensure the quality of the wheelchair, during the maintenance, if any consumable parts such as battery, wheels, joystick, motor/actuator, and charger need to be replaced, please contact the company or dealer, replacing the original parts of the same model and specification.

Your wheelchair, like most electrical and mechanical equipment, is susceptible to external conditions. In any case, the wheelchair should be avoided in a damp environment. Direct or prolonged exposure to water or dampness could cause the wheelchair to malfunction electronically and mechanically. Water can cause electrical components to corrode. Some parts of your wheelchair are susceptible to temperature. In extremely cold temperatures, the battery may become frozen. Special temperatures may cause a lot of factors to freeze, like charger type, usage, battery components (such as sealed lead-acid batteries or gel batteries). Temperatures above 55° may cause your wheelchair's speed to reduce.

Avoid beating the controller, especially the joystick. Avoid prolonged exposure of your wheelchair to extreme conditions, such as hot, cold, or moisture environments. Keep the controller clean. Check all electric connections, including the cable and connectors of the charger, and ensure that they are all tight and secure. If only the red LED on the Battery Gauge lights, the batteries are nearly running out of charge. You should recharge the batteries as soon as possible. We recommend charging the battery for 8 to 12 hours. Check the rear wheel inflatable situation, if the tire deformed seriously when riding, it should be inflated. The frame surface has been sprayed with a clear sealant coating. You can apply a light coat of car wax to keep the surface a high gloss.

Feather™

Check all cable connections. Make ensure they are fastened and are not corroded. The battery must be placed in the battery area, flat, the battery plug inward, relative display, refer to the correct connection on the main frame label. All wheel bearings are lubricated and sealed. Do not need to lubricate them. Check if there is a loose phenomenon for the wheel hub, drive device, and chair itself; if loose, please screw tightly in time.

Notice to Caretakers

Make sure that you pay careful attention to all warnings and follow all instructions in each section of this manual. (Be aware that warnings that apply to the rider will also apply to you).

It is important that you pay close attention to all warnings in this section. If you fail to do so, you may fall, tip over or lose control resulting in severe injury to you or others.

Modifications

The manufacturer has designed and engineered your wheelchair to provide maximum mobility and utility. A wide range of accessories items are available from your authorized provider to further customize your wheelchair and to better suit your needs and preferences. However, under no circumstances should you modify, add, remove, or disable any feature, part, or function of your wheelchair.

WARNING! Do not modify your wheelchair in any way not authorized by the manufacturer. Do not use accessories if they have not been tested or approved for your specific wheelchair.

Pre-Ride Safety Check

Get to know the feel of your wheelchair and its capabilities. The manufacturer recommends that you perform a safety check before each use to make sure your wheelchair operates smoothly and safely. Before operating your wheelchair you should be trained in the safe use of this wheelchair by your authorized Provider.

Perform the following inspections prior to using your wheelchair:

- Check all wheels are in full operating condition and free from dings, erosions, and are making full contact with the ground.
- Check all hand brakes.

Feather™

Weight Limit

- Never exceed the product weight capacity of 265 lbs for the rider plus any additional items.
- Exceeding the product weight limit is likely to damage the seat, frame, or fasteners and may cause severe injury to you or others.
- Exceeding the weight limit will void the warranty of this product.

MANDATORY! Stay within the specified weight capacity of your wheelchair. Exceeding the product's weight capacity will void your warranty. The manufacturer will not be held responsible for injuries and/or property damage resulting from failure to observe weight limitations.

WARNING! Do not carry passengers in your wheelchair. Carrying passengers on your wheelchair is exceedingly dangerous and may affect the center of gravity, resulting in a tip or a fall.

WARNING! Do not carry baggage weighing more than 10 lbs (4.5 kg) on the back of the wheelchair. Carrying or tying baggage in excess of 10 lbs. (4.5 kg) on the back of the wheelchair may affect the center of gravity, resulting in a tip or a fall.

WARNING! Do not incline forward when operating, especially on stairs and uneven roads.

Tie Down System

This Feather product is not approved to be used with any tie down system, and is not authorized to be used to transport a seated user in a motor vehicle. Your wheelchair was designed to be folded and stored in a secure location, such as the trunk of a car, during motor vehicle transport. In addition, all removable wheelchair parts, including the armrests and front riggings should be removed and/or properly secured during movement.

- Never sit in this Feather product while in a moving vehicle. In an accident or sudden stop you may be forced out of the wheelchair from the impact.
- Never transport this Feather product in the front seat of a vehicle. It may interfere with driving.
- Always secure this Feather product, with no one sitting in it, so that it cannot roll or shift.

WARNING! Do not sit on your wheelchair while it is in a moving vehicle.

WARNING! When cornering sharply, reduce your speed and maintain a stable center of gravity. This greatly reduces the possibility of a tip or fall.

Feather™

Cornering Information

While your wheelchair is equipped with front caster wheels, excessively high cornering speeds can still create the possibility of tipping. Factors which affect the possibility of tipping include, but are not limited to: cornering speed, steering angle (how sharply you are turning), uneven road surfaces, inclined road surfaces, riding from an area of low traction to an area of high traction (such as passing from a grassy area to a paved area – especially at high speed while turning), and abrupt directional changes. If you feel that you may tip over in a corner, reduce your speed and steering angle (ie, lessen the sharpness of the turn) to prevent your wheelchair from tipping over.

Incline Information

More and more buildings have ramps with specified degrees of inclination, designed for easy and safe access. Some ramps may have turning switchbacks (180 degree turns) that require you to have good cornering skills on your wheelchair.

- Proceed with extreme caution as you approach the downgrade of a ramp or other incline.
- Take wide swings with your wheelchair's front wheels around any tight corners. If you do that, the wheelchair's rear wheels will follow a wide arc, not cut the corner short, and not bump into or get hung up on any railing corners.
- When operating down a ramp, proceed slowly to ensure a safely controlled descent.
- Avoid sudden stops and starts.

When climbing an incline, try to keep your wheelchair moving. If you must stop, start up again slowly and accelerate cautiously. When operating down an incline, proceed slowly. If your wheelchair starts to move down the incline faster than you anticipated or desired, bring it to a complete stop using both hands, then proceed slowly to ensure a safely controlled descent.

WARNING! When on any sort of an incline or decline, never allow the wheelchair to roll freely while seated on it or standing next to it.

WARNING! When climbing an incline, do not zigzag or drive at an angle up the face of the incline. Drive your wheelchair straight up the incline. This greatly reduces the possibility of a tip or a fall. Always exercise extreme caution when negotiating an incline.

WARNING! You should not travel up or down a potentially hazardous incline (ie areas covered with snow, ice, cut grass, or wet leaves)

Feather™

WARNING! Never travel down an incline backward. Doing so may cause the wheelchair to tip over. Always exercise extreme caution when negotiating an incline.

WARNING! If your wheelchair is equipped with an optional carry bag mounted to the seat back, do not overload the bag or exceed the maximum load rating of the bag. Doing so could cause instability in your wheelchair when negotiating inclines, causing it to tip.

WARNING! Any attempt to climb or descend a slope steeper than 5° (8.7%) may put your wheelchair in an unstable position and cause it to tip over.

Outdoor Driving Surfaces

Your wheelchair is designed to provide optimum stability under normal driving conditions, which are dry, level surfaces composed of concrete, blacktop, or asphalt. However, the manufacturer recognizes that there will be times when you will encounter other surface types. For this reason, your wheelchair is designed to perform admirably on packed soil, grass, and gravel. Feel free to use your wheelchair safely on flat lawns and in park areas.

- Avoid driving on uneven terrain and/or soft surfaces.
- Avoid tall grass that can entangle the wheel spokes.
- Avoid loosely packed gravel and sand.
- Avoid uneven surfaces.
- Do not use your wheelchair in any water mass, fresh water, or saltwater.
- Do not use your wheelchair at the edge of any stream, lake, ocean, or body of water.
- If you feel unsure about a driving surface, avoid that surface.

Inclement Weather Precautions

Exposure of your wheelchair to inclement weather conditions should be avoided whenever possible. If while operating the wheelchair, you are caught in sudden rain, snow, severe cold, or heat, proceed to shelter at the earliest opportunity. Thoroughly dry your wheelchair and inspect for damage to all components before storing or resuming use of this product.

WARNING! Operating in rain, snow, salt, mist or spray conditions, and on icy or slippery surfaces can have an adverse affect on your wheelchair. Maintain and store your wheelchair in a dry and clean condition.

Feather™

WARNING! Prolonged exposure to hot or cold conditions may affect the temperature of upholstered and non-upholstered items on the wheelchair, possibly resulting in skin irritation. Exercise caution when using the wheelchair in extremely hot or cold conditions or when exposing your wheelchair to direct sunlight for prolonged periods of time.

WARNING! Wheelchairs are not designed to travel up or down stairs or escalators. Always use an elevator. Never use your wheelchair to negotiate steps or escalators.

WARNING! Never reach, lean, or bend while seated in your wheelchair. It is important to maintain a stable center of gravity and keep the wheelchair from tipping over. Never reach down between your knees or over the back of the seat as these movements can change your center of gravity and the weight distribution of the wheelchair. This may cause your wheelchair to tip over.

WARNING! Consult your physician if you are taking prescribed or over-the-counter medication or if you have certain physical limitations. Some medications and limitations may impair your ability to operate your wheelchair in a safe manner.

WARNING! Do not operate your wheelchair while you are under the influence of alcohol, as this may impair your ability to operate your wheelchair in a safe manner.

WARNING! The manufacturer strongly recommends that you do not smoke cigarettes while seated in your wheelchair, although your wheelchair has passed the necessary testing requirements for cigarette smoking, it is unsafe to smoke while operating your wheelchair.

WARNING! The manual wheel locks are designed to keep your chair stationary while you are parked. They are not designed to stop the wheelchair while driving. Do not use either of the manual wheel locks to stop the wheelchair while driving.

Public Streets and Roadways

WARNING! You should not operate your wheelchair on public streets or roadways. Be aware that it may be difficult for traffic to see you when you are seated on your wheelchair. Obey all local pedestrian traffic rules. Wait until your path is clear of traffic and then proceed with caution.

Feather™

Service Checks

WARNING! Never service or repair the wheelchair when the seat is occupied or in use.

It is important to perform regular safety checks in order to maintain the life and quality of the wheelchair and ensure your product is functioning properly.

- Check for loose or missing screws, nuts, and bolts. Replace or tighten them as necessary.
- Check for flat spots on solid tires. Flat spots could adversely affect stability.
- Check all manual wheel locks and brakes. Make sure they are working properly.
- Check the caster forks for damage or fluttering which indicates that they may need to be adjusted or have the bearings replaced.

Keep your wheelchair clean and free of foreign material, such as mud, dirt, hair, food, and drink.

Positioning Belts

Your authorized provider, physical therapist, or other healthcare professional is responsible for determining your requirement for a positioning seat belt, if necessary to operate your wheelchair safely. No positioning belt or seat belt should ever be used as a restraining device in a motor vehicle. All users should be properly belted into seats approved by the vehicle manufacturer with the wheelchair properly stowed for vehicle transport.

WARNING! If you require a positioning belt to safely operate your wheelchair, make sure it is fastened securely in order to reduce the possibility of a fall from the wheelchair.

WARNING! The positioning belt is not designed for use as a seat belt in a motor vehicle. Nor is your wheelchair suitable for use as a seat in any vehicle.

Feather™



Feather™

Warranty Information

The Feather Power wheelchair comes with a limited warranty and the following coverage:

- **Frame:** The manufacturer covers the frame of its mobility chair under normal use for a lifetime limited warranty period. The manufacturer will at its sole discretion, repair or replace, any warrantable frame that fails within the warranty period.
- **Wearable Parts:** The manufacturer will at its sole discretion, repair or replace, any wearable parts for a period up to 6 months.

The warranties herein specified shall not apply if the failure of any component of this product to satisfy such warranty is due to accident, neglect, misuse, improper transportation arranged by the purchaser or its agent, or causes other than ordinary use including operation contrary to the manufacturer's operating instructions or if any person other than the manufacturer's authorized personnel shall modify, adjust, or repair such product or perform any related service on it. It must be understood that the purchaser assumes full responsibility for the overall safe operation in the environment for which the product is intended to function.

Warranty Exclusions

The manufacturer will not be responsible for,

- Repairs or modifications made to any part or section of the wheelchair product without specific prior written consent from the manufacturer.
- Circumstances beyond the control of the manufacturer.
- And fees associated with or caused by service, labor, service calls, shipping, or other charges incurred for repair of the product unless specifically authorized in advance by the manufacturer.
- Any damage caused by: abuse, misuse, accident, or negligence of the wheelchair product; improper operation, maintenance, or storage of the wheelchair product; or any commercial use of the wheelchair product.

Official Feather Parts

The hardware and parts of your Feather product are specially designed, high-strength items. Replacing any hardware or wheelchair components with non-approved parts may result in faulty operation of your Feather product and may cause harm to the end user. Using non-official brand parts or making unauthorized changes to a Feather product will void the product warranty.

Thank you for your purchase!!

Feather™

See the complete line at [FeatherMobility.com](https://feathermobility.com)

Feather – the World's Lightest Wheelchairs and Scooters

<https://feathermobility.com>



Feather



Feather



Feather



Feather

